



RIDE YOUR OWN WAY





RIDE YOUR OWN WAY

Can we write the editorial for our 2022 Catalog without mentioning corona and climate change? No, we can't. Because both of these crises have made it clearer than ever that cycling is much more than just a means of transport.

Many customers have told us how important their delta trike was for their physical and mental well-being during lockdown. For example, Samuel (photo left), whom we've been in contact with for years, had an extraordinary summer

of cycling with his parents on the TRIX after his boarding school was forced to close due to pandemic restrictions.

Owing to climate change, cycling has finally become a political issue. In terms of "emission-free mobility," the new PINO, with its telescoping frame, can take the place of a car – or at very least, a second car. We even put this claim to the test with our "PINO Car Swap" campaign. On page 54, you can read about the results.







*BORN TO
BE CHILD*







ON THE ROAD AGAIN



CONTENTS

E-POWER _____ 10

01. *DELTA TRIKES FOR LIFE* _____ 12

KETTWIESEL EVO STEPS _____ 14

KETTWIESEL CROSS STEPS _____ 16

KETTWIESEL HANDBIKE _____ 18

TRIGO NEXUS _____ 20

TRIGO UP _____ 22

LEPUS STEPS _____ 24

Advantages of Delta Trikes _____ 26

Accessories and Options for Delta Trikes _____ 28



→ *OVER THE WUPPER* _____ 32

02. *TANDEM FOR EVERYONE/EVERYTHING* _____ 36

PINO STEPS _____ 38

PINO TOUR _____ 40

Versatile and Ergonomic _____ 44

Tandem as Family Taxi _____ 48

PINO Advantages _____ 50

Accessories for Tandems _____ 52



→ *PINO CAR SWAP* _____ 54

03. *ADAPTIVE TRIKES FOR KIDS* _____ 64

TRIX _____ 66

TRETS _____ 68

Adaptive Cycling Tips _____ 70

Family Tandem _____ 71



→ *WELCOME TO WALTROP* _____ 72

04. *SPECIAL ACCESSORIES* _____ 76

Special Accessories and Options _____ 78

HASE BIKES DEALERS _____ 84

HASE BIKES ONLINE _____ 85

DELTA TRIKES FOR LIFE

14 – 31



KETTWIESEL EVO STEPS
Luxury-Class E-Trike



KETTWIESEL CROSS STEPS
Offroad Trike with E-Power



KETTWIESEL HANDBIKE
Special Trike with Hand Cranks



TRIGO NEXUS
Modular Trike with E-Option



TRIGO UP
Recumbent Trike with Above-Seat Steering



LEPUS STEPS
Comfort Trike with Higher Seat

TANDEMS FOR EVERYONE/EVERYTHING

36 – 53



PINO STEPS
E-Tandem with Cargo Capacity



PINO TOUR
Touring Tandem for Globetrotters

ADAPTIVE TRIKES FOR KIDS

64 – 71



TRIX
Recumbent Wonder-Trike



TRETS
Junior Trike with Wow-Effect



GIVE ME AN E! MOTORS FOR HASE BIKES

HEINZMANN DIRECT POWER

Hub motor for special trikes

- _ Max. output 250 W
- _ 9.9 lb (4.5 kg) motor, 6.4 lb (2.9 kg) battery
- _ Assistance up to 15 mph (25 km/h)
- _ Adjustable to rider
- _ Max. torque 60 Nm
- _ Lithium-ion battery, 11 Ah capacity, 400 Wh

Models

HANDBIKE / KETTWIESEL / LEPUS / TRIX

SHIMANO STEPS E5000

Mid-motor retrofit kit for TRIGOs

- _ Max. output 250 W
- _ 5.3 lb (2.4 kg) motor, 6 lb (2.7 kg) battery
- _ Assistance up to 15 mph (25 km/h), in 3 modes
- _ Walk assist function
- _ Max. torque 40 Nm
- _ Lithium-ion battery, 11.6 Ah capacity, 418 Wh, 1000 recharge cycles, portable

Models

TRIGO NEXUS / TRIGO UP

SHIMANO STEPS E6100

Mid-motor for all STEPS models

- _ Max. output 250 W
- _ 6.2 lb (2.8 kg) motor, 5.7 lb (2.6 kg) battery
- _ Assistance up to 15 mph (25 km/h), in 3 modes
- _ Walk assist function
- _ Max. torque of 60 Nm with derailleur; 50 Nm with gear hub
- _ Lithium-ion battery, 14 Ah capacity, 504 Wh (optimal 600 Wh), 1000 recharge cycles, portable

Models

KETTWIESEL / LEPUS / PINO / TRIX

MOTORS FOR MOBILITY

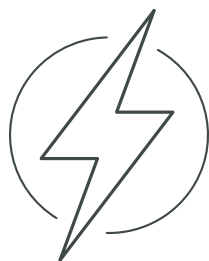

For years, we have sworn by Shimano Steps mid-motors for our electric bikes and trikes. They are extremely reliable and have a sophisticated system of sensors that offer smooth and quiet assist, guaranteeing an incredibly natural riding feel. For our custom models, we also offer Shimano's latest innovation, the EP8, as an option. The lightweight motor with a magnesium housing is a compact power pack with an impressive 85 Nm of torque.

The Heinzmann Direct Power is the only front-wheel motor in our portfolio. It can't offer the same maximum efficiency as a mid-motor and doesn't have the best range, but it's nevertheless unbelievably powerful and individually adjustable. The ideal choice for riders with limited muscle strength, e.g. with handbikes and adaptive bikes.

SHIMANO EP8

Mid-motor with extra power for custom models

- Max. output 250 W
- 5.7 lb (2.6 kg) motor, 5.7 lb (2.6 kg) battery
- Assistance up to 15 mph (25 km/h), in 4 modes
- Walk assist function
- Max. torque of 85 Nm with derailleur and Rohloff gera hub; 50 Nm with other gear hub
- Lithium-ion battery, 14 Ah capacity, 504 Wh (optimal 600 Wh), 1000 recharge cycles, portable

Models

KETTWIESEL / LEPUS / PINO / TRIK



AUTOMATIC SHIFTING: SHIMANO DI2 ALFINE

01

Works perfectly with STEPS motors: The integrated, electronic 8-speed internal hub monitors your torque, speed, and cadence, for fast, precise, and smooth shifting into the appropriate gear. Good to know: A mechanical shifting system is recommended for use with the EP8 in order to harness the motor's full power.



02

LICENSE TO RETROFIT: THE TRIGO MODELS

02

The modular TRIGOs were the world's first vehicles that were allowed to be retrofitted with the Steps system. The Retrofit Kit is installed by dealers in order to ensure maximum safety and insurance compliance.





01.

DELTA TRIKES

FOR LIFE

GENERATION TRIKE

If fifty is the new forty, and seventy is the new sixty, then we'd like to propose our own proverb: The trike is the new bike. Why? Because the delta trikes from HASE BIKES are fun to ride at any age but become an even more attractive option as we get older – due to their great stability and comfort. And because we're such visual creatures, HASE BIKES makes sure that its trikes not only are sporty to ride but also look the part. So modern and dynamic that you'll feel like a kid again.

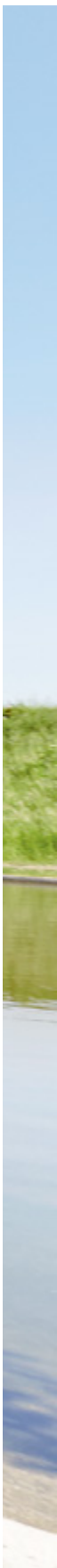



EXTRAVAGANT. EXQUISITE. EVOLUTIONARY.

— The EVO STEPS is the luxury model of our KETTWIESEL series. Some may argue that the name “KETTWIESEL” is too whimsical for this classy set of wheels, but what’s named is named. Moreover, it’s long since become the epitome of a sporty, high-end trike.

The EVO STEPS is our upgraded version for riders with even higher standards for comfort: It features sumptuous suspension, a Shimano Steps motor, and the corresponding Di2 electronic shifting system. The eye-catching, concrete-gray e-trike also makes a big impression with its small footprint: When parked upright, it’s a real space-saver, and when folded for transport, it can fit into almost any trunk with a length of 53 inches (134 cm).



KETTWIESEL EVO STEPS

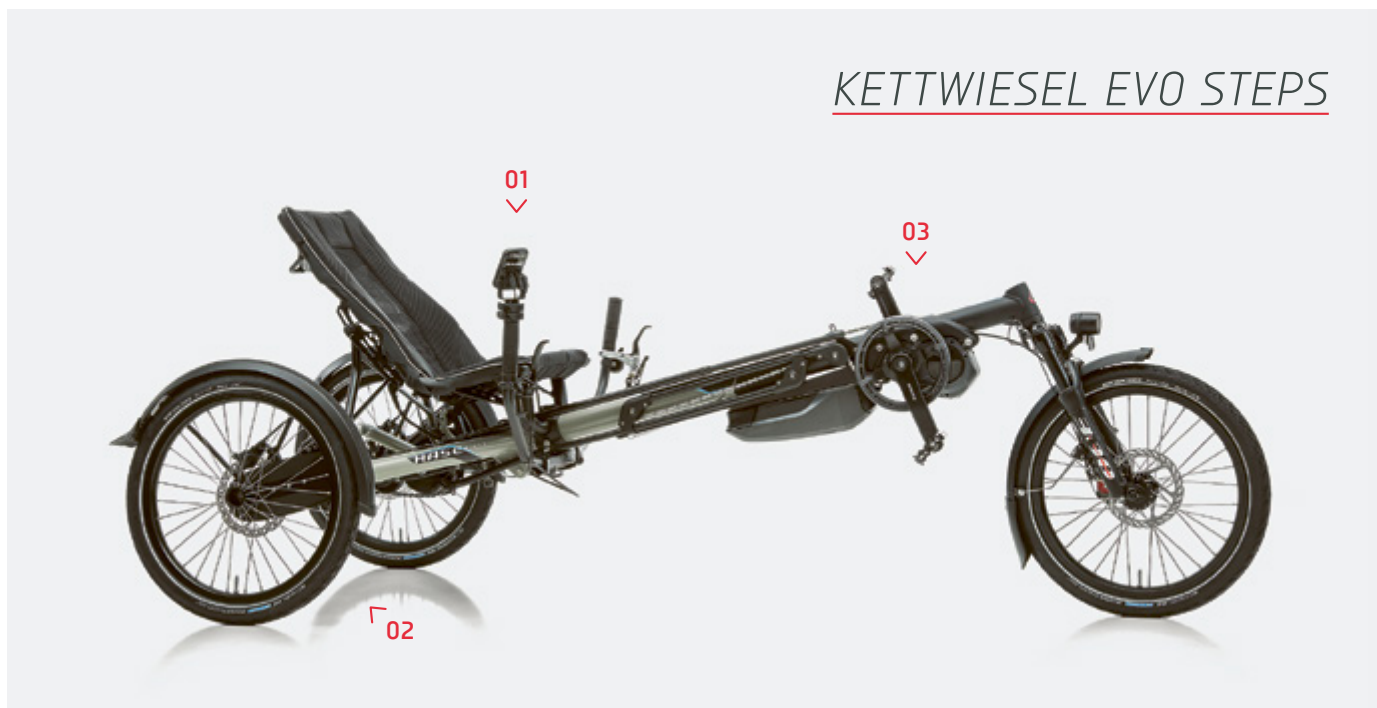

Specs and Features

- _ Aluminum, quick-adjust frame, foldable
- _ 79-92 x 35 x 32 in. (201-233 x 89 x 82 cm), folded 53 x 35 x 26 in. (134 x 89 x 66 cm), seat height 19½ in. (50 cm), bottom bracket height 20½ in. (52 cm)
- _ 71.6 lb (32.5 kg), max. load 309 lb (140 kg)
- _ Shimano Steps E6100 electric-assist motor, 504 Wh battery
- _ Full-suspension, HASE BIKES EVO rear-wheel suspension system, suspension fork Spinner 300
- _ Alfine Di2 8-speed gear hub
- _ HASE BIKES Differential
- _ Coupled brakes, right lever for hydraulic rear-wheel brakes, left lever for mech. front-wheel brake
- _ Crankset 170 mm 44 T
- _ black aluminum double-walled rims, SAPIM stainless-steel spokes
- _ Matte black SKS fenders
- _ Lights powered by motor battery: B+M IQ-X headlight / B+M Toplight Flat 2C Plus
- _ Concrete-gray, semi-gloss

Detailed information on specs and features can be found at <https://konfigurator.hasebikes.com/en/>. The model KETTWIESEL is also available in various basic versions without a motor.



01

Push it: The Shimano Alfine Di2 is an 8-speed, electronic, internally geared hub that coordinates perfectly with the motor. It can be operated in either manual or automatic mode. The rider can switch between these modes with the touch of a button under the display.



02

At some point, we're just too old for unnecessary bumps and jolts. That's why the EVO comes with **full suspension**: independent wheel suspension, air shocks, and cornering-stability control like a car. A sporty ride doesn't have to be uncomfortable.



03

A top speed of 15 mph (25 km/h): **Shimano Steps**. The powerful – yet smooth and quiet – mid-motor gives you more traction on the rear wheels than a front motor. Its battery has a 504 Wh capacity and can be fully charged in a mere four hours.



UP AND DOWN AND WOO-HOO!

— This is the CROSS. The KETTWIESEL CROSS. Also known as the mountain trike, the all-terrain delta, or the daredevil of the HASE BIKES family. The yellow bullet with the knobby treads sails serenely over roots and rocks, carves up the tightest corners, and keeps the squirrels watching safely from the trees.

The chassis? Superbly sporty. The gears? With ample ground clearance. The suspension? Independent wheel suspension with a sway bar and special air shocks. Anything else? Of course: So that uphill is as fun as downhill, the CROSS comes with a Differential, which transmits power to both rear wheels. And the tires almost never lose traction, because the rider's weight is over the rear axle. Sound good? It's out of this world!





reddot award 2015
best of the best

KETTWIESEL CROSS STEPS



Specs and Features

- Aluminum, quick-adjust frame, foldable
- 79-92 x 35 x 32 in. (201-233 x 89 x 82 cm), folded 53 x 35 x 26 in. (134 x 89 x 66 cm), seat height 19½ in, seat height 19½ in. (50 cm), bottom bracket height 20½ in. (52 cm)
- 66 lb (30 kg), max. load 309 lb (140 kg)
- Shimano Steps E6100 electric-assist motor, 504 Wh battery
- Full-suspension, HASE BIKES EVO rear-wheel suspension system, Spinner 300 suspension fork
- HASE BIKES 11-speed linear derailleur, Shimano 11-42 cassette, bar end shifters
- HASE BIKES Differential
- Coupled brakes, right lever for hydraulic rear-wheel brakes, left lever for mechanical front-wheel brake
- Crankset 170 mm 48 T
- Cross tires, black aluminum double-walled rims, SAPIM stainless-steel spokes
- Yellow, semi-gloss

Detailed information on specs and features can be found at <https://konfigurator.hasebikes.com/en/>. The model KETTWIESEL CROSS is also available in a basic version without a motor.

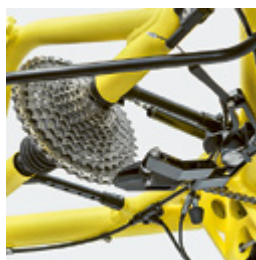

01

Bottoming out on jump landings? Ouch. That's why, for the CROSS, we developed a **linear derailleur** that would offer more ground clearance than standard derailleur cages. The 11-speed system made from CNC-machined aluminum is sophisticated, but not finicky. And it's also very forgiving of shifting mistakes.



02

Riders who aren't able or willing to rely on pure muscle power can switch on the **Shimano Steps** mid-motor any time they need support. The smooth and quiet system is seamlessly integrated into the bottom bracket ... and makes ascents feel like straightaways.



03

You can ride your CROSS to the bike park, but if asphalt is just too boring, the station wagon will get you there, too. Thanks to the ingenious **folding mechanism**, three quick steps are all it takes to transform the trike into a compact unit measuring as little as 53 inches (134 cm) in length. Brilliant, isn't it?



TAKING FUN INTO YOUR OWN HANDS

Experience the exhilaration of riding first-hand: The KETTWIESEL HANDBIKE comes with a specially developed hand-crank assembly that efficiently transfers the power from your arms to the wheels. The adjustable leg supports offer comfortable stability and protection for the lower body.

The KETTWIESEL HANDBIKE doesn't wobble when mounting, and the seat has the perfect height for easy transfer from a wheelchair. Another delta-trike advantage: Thanks to rear-wheel drive, the traction is so grippy that even uphill rides are fun. If your region is hilly, you will really appreciate the standard Differential. And riders looking for even more luxury can add a powerful Heinzmann hub motor.



KETTWIESEL HANDBIKE



Specs and Features

- Aluminum frame/fork
- 63–80½ x 37½ x 34 in. (160–205 x 86 x 95 cm), pack size 63–80½ x 34 x 21 in. (160–205 x 86 cm x 53), seat height 18 in. (46 cm), hand-crank length 174 mm
- 53 lb (24 kg), max. load 309 lb (140 kg)
- 8-speed Nexus gear hub with twist shifters / Mountain Drive
- HASE BIKES Differential
- Coupled brakes, right lever for hydraulic rear-wheel brakes
- Comfort tires, black aluminum double-walled rims, SAPIM stainless-steel spokes
- Matte black SKS fenders
- Lighting: Herrmans Black MR8 50 LUX headlight / B+M Toplight 2C plus taillight
- Carmine red, semi-gloss

Detailed information on specs and features can be found at <https://konfigurator.hasebikes.com/en/>. The model KETTWIESEL HANDBIKE can also be equipped with an optional Heinzmann Direct Power motor.



01

At your fingertips: As with most bikes, the HANDBIKE's shifters and brake levers are mounted to the handlebar grips. The only difference is that these grips also function as hand pedals. Sounds a lot like multitasking, but the controls are actually very easy to learn.

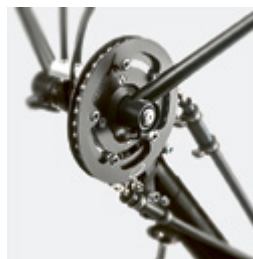

02

The **hand cranks** are available in two different sizes: 174 and 150 millimeter. This makes it possible to adapt the HANDBIKE to the rider for perfect ergonomics.

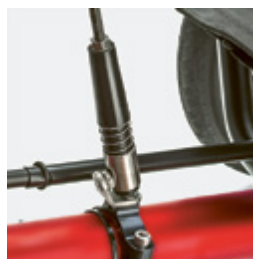

03

The **hand-crank assembly** is intelligently designed: Its position can be adjusted to the rider's size and preferences by moving the support bar. In addition, it can be folded forward to make it easier to get into and out of the seat.



STANDING OVATIONS FOR A RECUMBENT TRIKE

With the TRIGO NEXUS, you can enjoy the exhilaration of delta triking without blowing your budget! How, you ask? Like this: Thanks to its modular construction, the TRIGO NEXUS is not only less expensive to produce but also highly versatile. And it offers the amazing option of retrofitting a Shimano Steps mid-motor if it fits to your budget!

The modules move along guide rails and are infinitely adjustable. Therefore, the TRIGO can be quickly adjusted to different riders with no need for tools. Provided that the rider is between 4'7" (1.40m) and 6'7" (2m) in height. And provided you're willing to share your favorite trike.



TRIGO NEXUS



Specs and Features

- _ Aluminum frame and fork
- _ Under-seat steering
- _ 70½–82½ x 32½ x 39–42 in. (179–210 x 83 x 98.5–106.5 cm), seat height 23–26 in. (58.5–66.5 cm), bottom bracket height 12½ in. (32 cm)
- _ 47 lb (21.5 kg), max. load 309 lb (140 kg)
- _ 8-speed Nexus gear hub, twist shifters
- _ Promax DSK-300F mechanical disc brakes with parking-brake mechanism
- _ Crankset Samox 155 mm 36 T
- _ Puncture proof tires with reflective sidewalls
- _ Carmine red/black

Detailed information on specs and features can be found at <https://konfigurator.hasebikes.com/en/>. The model TRIGO NEXUS can be retrofitted with a Shimano Steps motor at any time.



01

The **ergonomic seat** made from super-comfy black mesh helps you put full power to the pedals. The seat tilt can be set to your preferred position using a quick-release mechanism.



02

Thanks to its modularity, the TRIGO can be easily adjusted to fit riders of all shapes and sizes. For the **stepless length adjustment**, all you have to do is open two levers and slide the seat into the appropriate position. No need for tools and no need to shorten or lengthen the chain.

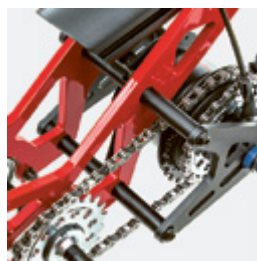

03

The TRIGO NEXUS gets its surname from its reliable and low-maintenance gear system. Thanks to the **Nexus 8-speed gear hub** with Shimano's Gear Change Support mechanism, the red cornering wizard offers smooth and crisp shifting. (Also available with Shimano 24-speed Altus Mix derailleur)



WHAT'S UP? THE TRIGO!

Who says that getting older means slowing down and wearing beige? The world is colorful, and so are we! And we'll "keep on rolling" as long as we can. The TRIGO UP was designed for young-at-hearts like us. With great stability, intuitive handling, and above-seat steering, the trike is a bright-red declaration of resistance against those spoilsport attitudes towards aging – and a call to unbridled riding fun!

There are so many perks to owning a TRIGO UP. For example, you'll always have a comfortable place to sit when visiting beautiful places. No tools are needed to adjust it to your loved ones' leg length. It can carry ample cargo. And you can always add a motor later if you need it – for example, when you're 99. Or 111. After all, we're not getting any younger.



TRIGO UP



01

Ingenious: **adjustable above-seat handlebars**. The handlebar height and angle, as well as the distance to the rider, can be adjusted without tools. And you can steer the trike just like you would an upright bike.

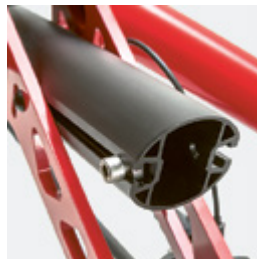

02

Special TRIGO accessories can be easily and securely mounted to the frame-tube insert at the back: e.g. the Guide Bar and the mounting bracket for the Racktime Basket.



03

Penny pinchers and athletic types can choose the non-motorized version of the TRIGO UP – and then retrofit a **Shimano Steps** mid-motor later. All it takes is a few easy steps to mount – or remove – the extremely quiet and efficient motor.

Specs and Features

- _ Aluminum frame and fork
- _ 70½–82½ x 32½ x 39–42 in. (179–210 x 83 x 98.5–106.5 cm), seat height 23–26 in. (58.5–66.5 cm), bottom bracket height 12½ in. (32 cm)
- _ 51 lb (23 kg), max. load 309 lb (140 kg)
- _ 8-speed Nexus gear hub, twist shifters
- _ Promax DSK-300F mechanical disc brakes with parking-brake mechanism
- _ Crankset Samox 155 mm 36 T
- _ Puncture proof tires with reflective sidewalls
- _ Carmine red/black

Detailed information on specs and features can be found at <https://konfigurator.hasebikes.com/en/>. The model TRIGO UP can be retrofitted with a Shimano Steps motor at any time.



HIGH ON COMFORT

— Advantage: visibility. The LEPUS STEPS scores points with its high seat: up to 25 inches (63 cm). This lets you pedal comfortably downwards – and ensures that you will “see and be seen” in traffic. Getting into the seat is as easy as sitting down in your favorite recliner: Just stand on one side, take a seat, and then lift one leg over the low frame tube in front.

The outstanding suspension is another reason why riders feel so safe on a LEPUS STEPS. The nimble trike is a dependable everyday companion not only for sporty riders of all ages, but also for people with physical limitations. Indeed, the LEPUS is not your run-of-the-mill upright trike, but a comfort-class recumbent. In other words: It’s living the high life.



LEPUS STEPS



Specs and Features

- Aluminum, quick-adjust frame, foldable
- 73–83½ x 35 x 37½ in. (186–212 x 89 x 95 cm), folded 48¾ x 35 x 24 in. (124 x 89 x 61 cm), seat height 25 in. (63 cm), bottom bracket height 17 in. (43 cm)
- 67 lb (30.5 kg), max. load 309 lb (140 kg)
- XXL seat
- Shimano Steps E6100 electric-assist motor, 504 Wh battery
- Rear suspension, HASE BIKES EV0 rear-wheel suspension system
- Alfine Di2 8-speed gear hub
- HASE BIKES Differential
- Coupled brakes, right lever for hydraulic rear-wheel brakes, left lever for mechanical front-wheel brake
- Crankset 170 mm 44 T
- black aluminum double-walled rims, SAPIM stainless-steel spokes
- Matte black SKS fenders
- Lights powered by motor battery: B+M IQ-X headlight / B+M Toplight 2C plus
- Carmine red, semi-gloss

Detailed information on specs and features can be found at <https://konfigurator.hasebikes.com/en/>. The model LEPUS is also available in a basic version without a motor.



01

No matter how sporty we'd like to be, sometimes our strength or willpower runs low. Then it's time to switch on the quiet **Shimano Steps** motor. It only provides assistance when you want it to and when the pedals are in motion. Once you've reached 15 mph (25 km/h), it switches off automatically.



02

To ensure that the LEPUS can also ride over cobblestones and other bumpy surfaces without losing its cool, the trike has independent **rear-wheel suspension** with air shocks. This provides not only comfort but also safety.

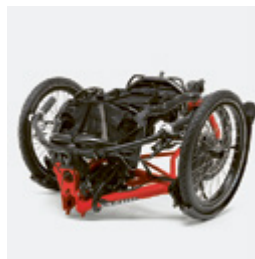

03

Thanks to its **foldable frame**, the comfortable trike is also easy to pack and transport: e.g. in a compact car. In just three easy steps – without tools – it can be transformed into a small unit measuring as little as 48¾ inches (124 cm) in length.

FREEDOM ON THREE WHEELS: DELTA TRIKES.

HASE BIKES only builds delta trikes. We're convinced that it's the best trike design. Deltas have two wheels in back, and one wheel in front that does the steering. The recumbent seat is positioned in the rear third of the trike between the front and rear axles. This design not only ensures exceptional stability and good traction, but also offers many other advantages:

SMALL TURNING RADIUS

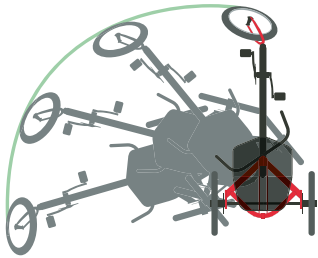

> Thanks to its geometry, a delta trike can turn on a dime – which can also be helpful when parking.

GET INTO THE SEAT COMFORTABLY

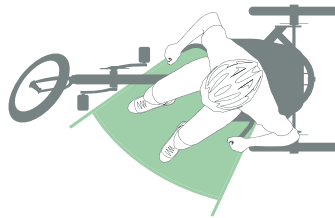

> When your delta trike is parked on level ground, you can sit down easily on the seat between the rear wheels.

UPRIGHT PARKING

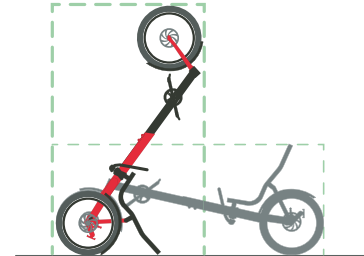

> Upright parking allowed! A delta trike can be parked with its front wheel in the air, which saves space indoors and is a real eye-catcher outdoors.

TWO-WHEEL DRIVE? NO PROBLEM!

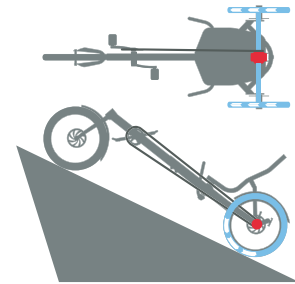

> With a delta trike, most of the weight rests on the rear axle, which translates into good traction for the rear wheels. If you add a Differential, which transfers the power to both rear wheels, it's even easier to power up steep hills – regardless of the road surface.

> Optimal uphill option: a Shimano Steps mid-motor!

AT EYE LEVEL WITH CAR DRIVERS

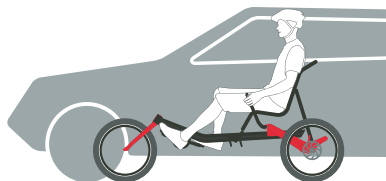

- > A high seat (extra high: with LEPUS) means more visibility. And more visibility means more safety. Nevertheless, it's always a good idea to ride with a safety flag!

ABOVE-SEAT STEERING

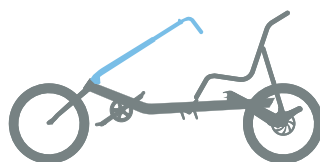

- > Thanks to the long frame and the single wheel in front that does the steering, it is possible to offer models with intuitive above-seat handlebars (TRIGO UP).

CAN BE HITCHED TO A BICYCLE

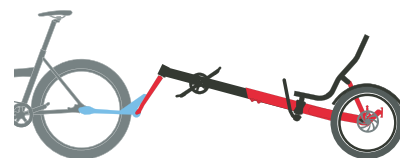

- > Perfect for family excursions: With the Trailer Kit, a delta trike (TRIX or KETTWIESEL Allround) can be hitched to a normal upright bicycle.

MORE GROUND CLEARANCE

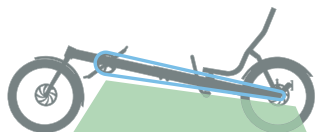

- > Although delta trikes are recumbents, they have the necessary ground clearance for everyday use. This means you shouldn't have any trouble riding safely over obstacles like curbs or ramps.
- > Riders who spend a lot of time on bumpy roads or offroad can order their trike with a linear derailleur, which offers more ground clearance than a standard derailleur cage. (Not available for TRETs or TRIGOs)

HITCHABLE FOR TANDEM USE



- > Two to one: With a Tandem Coupling, you can connect two delta trikes – for towing riders who need a little help, or just for fun.

ACCESSORIES AND OPTIONS FOR DELTA TRIKES



01

RAIN PROTECTION



01 Foldable Fairing

The fairing's patented folding system, the easy opening and closing, and of course the reliable protection from rain and wind have proven their worth over the years.

02 Rain Poncho

The rider enjoys significantly more freedom of movement and, thanks to the optimized side openings, the arms can slide comfortably in and out of the poncho. The Rain Ponchos, which VAUDE is producing for us, also have a new collar system that adds additional comfort by protecting the rider from cold air and wind, and keeping the neck and ears warm.

03 Rear-View Mirror

More perspective, more safety. The Rear-View Mirror comes with the Foldable Fairing and can be mounted on either side. Easy to adjust to many different positions, zero vibration.

04 Smartphone Mount for Foldable Fairing

Secure mount for practically all smartphone models. Developed for the Foldable Fairing.

05 TRIGO Fender Kit

The easy-to-mount fenders offer optimal protection from splashes and dirt. The set of three fenders in reliable SKS quality takes the eek out of puddles and the yuck out of mud – and is an easy way to make the TRIGO and the TRIGO UP even more practical for everyday use.

06 Rain Cover

Keeps moisture out and looks great. The Rain Cover for our recumbent seats is now even compatible with the XXL and TRIGO seat.



05



02



06

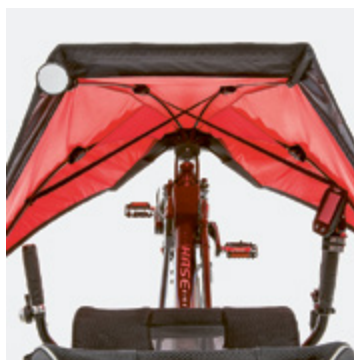

03



04



07



08



09



10



11



12



13

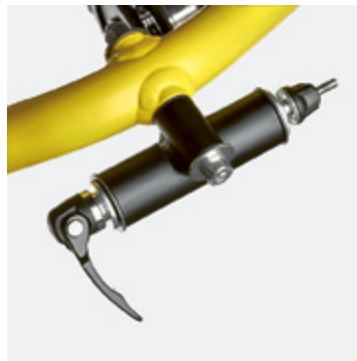

14

TRANSPORT



07 Roller Rack

A luggage rack with wheels and a fold-out pull handle. It can be mounted behind the seat and can carry heavy loads, e.g. beverage crates or a rollator. With the Roller Bag (see 08), it can even be used as a shopping basket with wheels.

08 Roller Bag

The 70-liter bag with reflective stripes is made of PU-coated ripstop nylon, which is 75% ultrasonically welded and therefore very waterproof.

09 Seat Bags, right and left

The Seat Bags are attached below the seat on both sides. A perfect place for keeping your papers, keys, and phone safe from the elements and easily reachable while on the road.

10 TRIGO Basket Mount

The Basket Mount for the TRIGO and TRIGO UP is compatible with various standard systems, like the "Baskit" from Racktime.

11 Universal Mounting Bracket

Use this bracket to hold the things you want to keep an eye on. Small, expensive accessories, like your smartphone, GPS device, or light, can be mounted safely and securely to the frame tube.

12 Lowrider Rack

Packing smart: Two panniers in front on the Lowrider Rack put more weight on the front wheel without affecting the handling.

13 Weber Hitch Adapter

Thanks to this adapter, it's possible to use your trike for pulling a trailer with a straight drawbar.

14 Tandem Coupling

Transforms two trikes into a trike tandem – as shown in the photo on the right. In order to hitch the rear trike, all you have to do is remove its front wheel, slide the coupling into the dropouts, and secure it with the quick-release.

HANDLEBARS



15 Above-Seat Handlebars TRETTS (optional)

Above-seat handlebars are intuitive to use because they are so similar to the handlebars of a "normal" upright bike. If your child prefers them to under-seat handlebars, then you can choose this option – and order the TRETTS with a classic "Easy Rider" look!



15

16 Parking Brake Lever

The small plastic lever that engages the brakes is intuitive to use, even for individuals with limited fine motor skills. Thanks to the fine steps of the locking mechanism, it can even be used with worn or poorly adjusted brakes. Also compatible with hydraulic brake systems!



16

SECURITY FEATURES



17 Frame Lock

Made by HASE BIKES for HASE trikes: with a special mount developed in-house and an additional steel cable for securing the frame.



17

DRIVE SYSTEMS



18 Differential (optional)

It's the invention that made the car possible. And on our trikes, it's the final ingredient for ultimate riding fun – especially on loose surfaces. Specially designed for the KETT-WIESEL, the Differential transfers the pedal power to both rear wheels. It shows its true colors on rough terrain or muddy slopes, where others skid out.



18

19 Differential TRIGO

A Differential was also specially developed by HASE BIKES for the TRIGO series and transfers the power reliably to both rear wheels. It's retrofittable and therefore fits perfectly to the outstanding flexibility of these modular trikes.



19



14





OVER

THE WUPPER

Spanning the valley of the river Wupper between Remscheid and Solingen, Müngsten Bridge is Germany's highest railway bridge. It has been described as a miracle of engineering and – as you can see – is a popular motif for photographers. However, our motif is even more miraculous: a man who after suffering two major strokes seven years ago was only able to lie in bed and stare at the ceiling and now cycles 32 kilometers a day.



Seven years ago, Dierk Fischer nearly “went over the Wupper,” a regional colloquialism for “kick the bucket.” Two major strokes changed his life overnight. He was paralyzed on one side of his body and wasn’t able to talk, walk, or even sit. All he could do was lie in bed and stare at the ceiling. “The white ceiling period” is still how he describes this depressing phase of his recovery.

After what felt like an eternity, he made his first attempts to use a wheelchair in the hospital. Later, he was transferred to a Düsseldorf clinic for rehabilitation. This is where an occupational therapist asked him

a simple question: “What do you want to be able to do again?” Mr. Fischer, who by that time had already regained his speech but was still pretty much bedridden, took a moment to think. Then he answered: “Ride a bicycle.” The goal was set but for the distant future because, at the time, he still had almost no sense of balance. On a normal bicycle, three people had to hold him up and push him, and even that felt “like climbing the north face of the Eiger.”

In search of an adaptive trike, he happened upon our website, became curious, and made an appointment at the nearest HASE BIKES dealer. The dealer recommended a LEPUS



and offered him a test ride ... which quickly ended in a ditch. "Nothing's broken! That just goes to show how well-built it is!" explained our dealer, which was enough to convince Mr. Fischer. He ordered a LEPUS STEPS with a motor and Single-Hand Controls.

FRIENDS FOR LIFE

On his 70th birthday, the brand-new trike was rolled into his house – as a present from his friends and family. It's so great to have people like that in your life! Dierk Fischer is grateful for the joy that the LEPUS has given him. "Cycling is half my life," he said. Every day he rides his "local route": 32 kilometers around his home in Wuppertal-Cronenberg.

The LEPUS has also accompanied him through the pandemic. It was pretty disappointing for him when the state bike tour was canceled due to the pandemic. He had already taken part in it several times with his wife, Gisela: 260 kilometers in three days, together with 1000 other cycling enthusiasts. Now he has his sights set on next year's event. Until then, he will be training on his daily route. Along the beautiful Wupper. ——— x

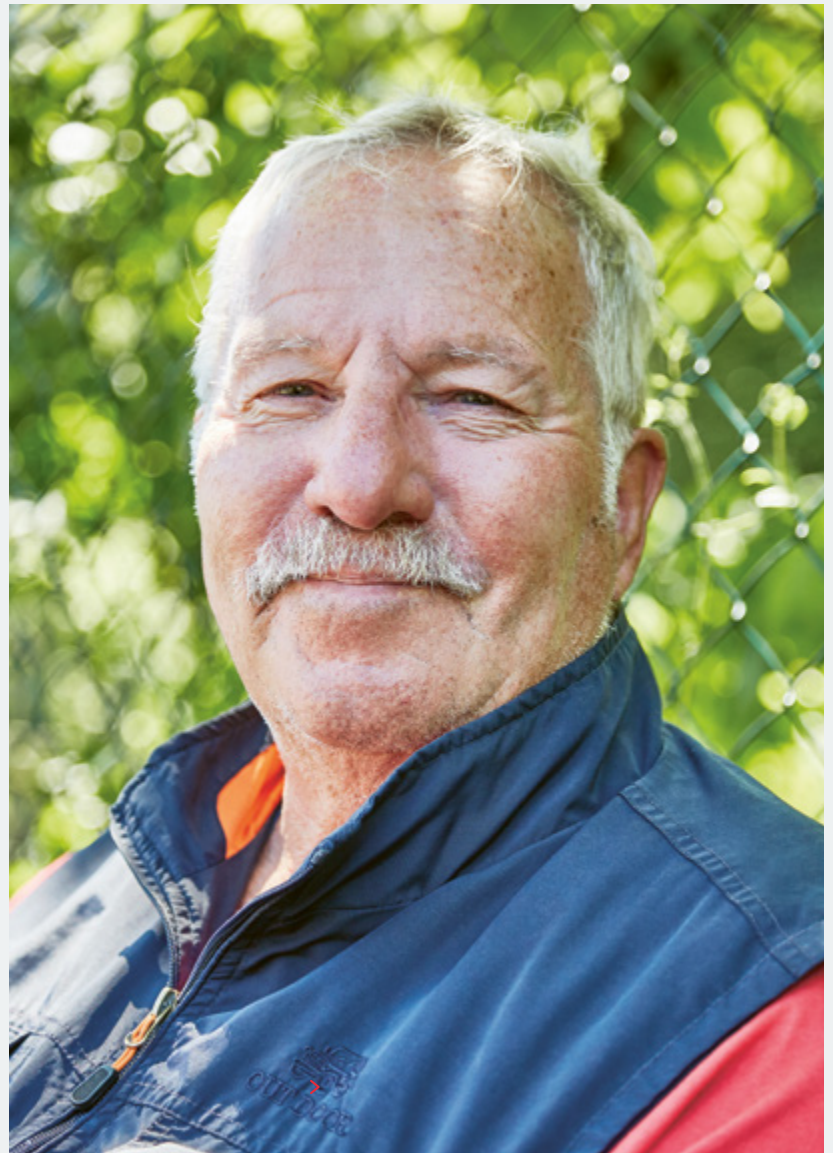





02.

TANDEMS FOR EVERYONE/ EVERYTHING

IS IT STILL A TANDEM?

Yes, it is. But it's also a family taxi and a cargo bike. In short: It's as versatile as a fleet of vehicles. It's a PINO. The PINO may not be the best bike for tandemists who would rather sit in the slipstream of the front rider and keep their hair in place than feel the wind in their face and enjoy a panoramic view. It is also not the best bike for kids who would rather sit, bundled up in a wooden box than be active co-pedalers in the front seat. And the PINO wouldn't be good at all for people who can't imagine transporting things without a car. But for everyone else – including us – it's the best tandem in the world.



E-POWER FOR CITY AND COUNTRY

— A picture is worth a thousand words – so what is there to add? Maybe that the front rider does not need any special skills, just a little trust in the rear rider. Or that the motor has a walk-assist function that makes it easier to push a fully loaded PINO. And that there's an extensive range of accessories for cargo, young riders and people with special needs – check out the section starting on page 52!

And now for a word that's worth a thousand pictures: climate protection. As a leisure bike, family taxi, and cargo bike all wrapped into one, the PINO STEPS is a truly viable alternative to owning a car. Truly. Or at least a second car.



PINO STEPS



Specs and Features

- aluminum frame, telescoping
- Length 72½–96½ in. (184–245 cm), width 23½–31½ in. (60–80 cm) or 9½ in. (24 cm) with the seat and pedals removed and the handlebars folded down, height 32¼–49¼ in. (83–125 cm)
- Wheelbase 46½–60¼ in. (118–154.5 cm)
- 73 lb (33 kg), maximum load 496 lb (225 kg)
- Shimano Steps E6100 electric-assist motor, 504 Wh battery
- Spinner 300 suspension fork
- Shimano 11-speed derailleur, Microshift bar-end shifters with Ergo grips
- hydraulic disc brakes
- HASE BIKES tandem crankset with integrated freewheel, rear: 170 mm right 44T/left 36T, front: 165 mm 38T
- rear rim aluminum double wall with double eyelets, SAPIM stainless-steel spokes
- Hub with thru axle and Boost standard
- SKS matte black fenders
- Lights powered by motor battery: B+M IQ-X, integrated taillight
- AtranVelo rear rack (max. 55 lb/25 kg)
- White, pearlescent high-gloss

Detailed information on specs and features can be found at <https://konfigurator.hasebikes.com/en/>. The PINO is also available in a basic version without a motor.



01

The **Shimano display** is mounted to the end of the handlebar, which is the ideal position for ergonomics and safety. Riders can easily keep an eye on all essential info – like speed, assistance level, estimated range, battery level, and much more – without having to turn their head or strain their neck.



02

Turns the PINO into a pedelec: the **Shimano STEPS E6100**. The lightweight 6.2lb (2.8 kg) mid-motor has a max. output of 250 W and provides three different assist modes: Eco, Normal, and High. The 504-Wh lithium-ion battery is portable and can be fully charged in a mere four hours.

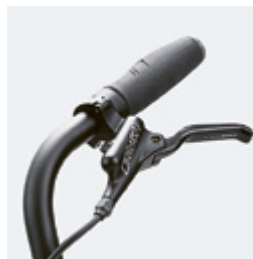

03

Be it two adult riders or heavy cargo: A large load requires strong brakes. This is why the standard version of the PINO STEPS is equipped with a **hydraulic disc brake system**, whose 4-piston calipers offer precision control at your fingertips.



TO THE ENDS OF THE EARTH OR INTO THE WALTROP OUTBACK.

At what point does a bike ride become a tour? When you've passed the 60-mile mark? After your first night under the stars? When you're carrying more than 40 pounds of luggage? In our opinion: as soon as you take off on your PINO TOUR. Once the panniers on the lowrider are packed and the tent, sleeping bags, and other supplies are strapped onto the rear rack, you can hardly wait to hop on and ride into the horizon. Then switch seats and continue down the path of wanderlust.

The PINO TOUR lets you explore the world with all your senses. The breeze plays with your hair, carrying with it a myriad of scents – from the roadside wildflowers, the grazing cattle, and the rustling pines. Okay, you may also catch a whiff of tractor diesel now and then ;-). But one thing's for certain: Every trip will feel like a tour. From the very first mile.



PINO TOUR



Specs and Features

- aluminum frame, telescoping
- Length 72½–96½ in. (184–245 cm), width 23½–31½ in. (60–80 cm) or 24 cm (9½ in.) with the seat and pedals removed and the handlebars folded down, height 32¾–49¼ in. (83–125 cm)
- Wheelbase 46½–60¼ in. (118–154.5 cm)
- 66 lb (30 kg), maximum load 496 lb (225 kg)
- Spinner 300 suspension fork
- 14-speed Rohloff Speedhub, compatible with 12 mm thru-axle frames, with twist shifter
- hydraulic disc brakes
- HASE BIKES tandem crankset with integrated freewheel, rear: 170 mm right 44T/left 38T, front: 165 mm 38T
- rear rim aluminum double wall with double eyelets, SAPIM stainless-steel spokes
- SKS matte black fenders
- Light from SON hub dynamo with thru axle: B+M IQ-X and Top lite Flat Brake plus
- Tubus Logo rear rack (max. 88 lb/40 kg), HASE BIKES Lowrider (max. 79 lb/36 kg)
- Blue, metallic high-gloss

Detailed information on specs and features can be found at <https://konfigurator.hasebikes.com/en>



01

A must-have for bike travel: the **Lowrider**. This heavy-duty HASE BIKES rack can hold one large and one small pannier on each side. Luggage that is carried in the front, under the recumbent seat, has no negative effect on handling and, in fact, provides for improved traction.



02

Another perfect place for luggage is in the back: the **Tubus Logo**. The narrow rack can shoulder up to 88 lb (40 kg). The panniers are carried extra-low for a lower center of gravity, which improves stability.



03

Top choice for long routes with varying levels of difficulty: The **14-speed Rohloff Speedhub** guarantees a smooth ride at all times, thanks to the linear gear ratios. Experienced touring cyclists swear by this low-maintenance gear hub, which is also practically indestructible.







*PINO. PINOO. PINOOO.
IT'S THAT ADJUSTABLE.*



The new PINO has a telescoping frame. But what does that mean? It means that you can shorten the wheelbase by simply pushing the front section into the main frame. And why would you want to do that? For example, to create a nimble cargo bike with the wheelbase of a normal city bike. Or to be able to park your family taxi in tight spaces in cellars, garages, or other parking areas. Or to shrink your tandem's wheelbase to that of a 29-inch mountain bike so that it can be carried on any rear-mounted car rack. That's why!



The picture that looks like a huge set of mechanical antlers is actually a photomontage of the PINO's new handlebars shown in various positions. For improved ergonomics, the handlebar width can be adjusted – without having to change the grip angle. The new handlebars are even height-adjustable, as shown by the smaller photomontage on the right. With this ingenious design, riders of any size and stature will be able to find the perfect handlebar position.

Versatile and Ergonomic



The robust handlebars are manufactured using swaging technology. They can be folded down into the transport position by loosening a single bolt and have adjustable stops for returning them to the preferred angle setting. If the recumbent seat is removed and the PINO is pushed together to its shortest length, then it fits onto any standard rear-mounted car rack. Which means it can be transported with almost any car!







RIDING IN FRONT? CHILD'S PLAY!

Oh what fun it is to ride! Kids as small as 3'3" (1 m) in height can get in on the action. And enjoy a front-row seat! They have a great view of their surroundings and can even call the shots. As co-pilots, they can also help with the pedaling instead of simply sitting idly in a trailer or child seat. But pedaling is optional, thanks to the freewheel mechanism. Which means that it's no problem at all if they forget to pedal now and then, for example when distracted by the pretty horses. And if they nod off after a long day at nursery school, Mom or Dad can easily keep an eye on their slumbering angel!

ADVANTAGES ... TO THE POWER OF 2: THE PINO.

Every tandem is the same. Except when it isn't - like the PINO. The PINO is a semi-recumbent tandem, which makes it multifunctional. The rear rider steers and shifts, while the front rider sits in an exceptionally comfortable recumbent seat. This principle of positioning the riders at two different heights offers a whole lot of advantages.

GREAT VIEWS

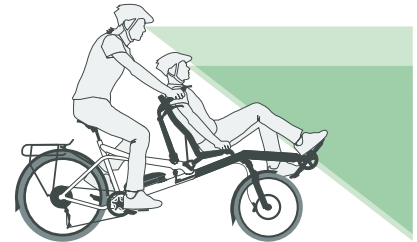

> PINO riders may not agree on everything... but they always share the same views. Unlike on a classic tandem, the rear rider on a PINO enjoys a panoramic view of the surroundings.

HOLDS A LOT OF CARGO



> With accessories like the Low Rider rack, which can carry up to four panniers under the front seat, the PINO is an ideal touring bike for both short and long excursions.

FREEWHEEL IN FRONT

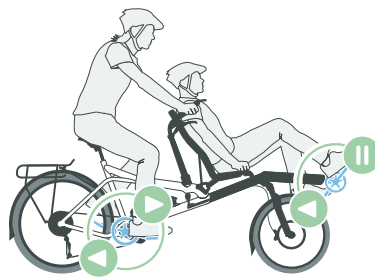

> Pedal whenever the spirit moves you. Otherwise, the front rider can chill, conk out, rest, nap ... or just forget to pedal because there's so much exciting stuff to look at.

COMFIER THAN ANY SADDLE

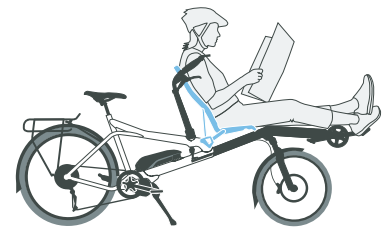

> Who needs a park bench? The ergonomic recumbent seat is so comfortable that it can also be used for relaxing in the shade.

WE NEED TO TALK



- > And you can ... without even having to raise your voice. Thanks to the special seat positions on the PINO, it's easy to prattle, plan, or philosophize.

CHILD AT DAWN, CARGO AT LUNCH



- > The foldable Porter Bag transforms the recumbent seat into a shopping bag with a capacity of 120 liters. The Porter Rack can hold bulky and heavy cargo items – e.g. two beverage crates.

OUT IN FRONT WITH SPECIAL NEEDS

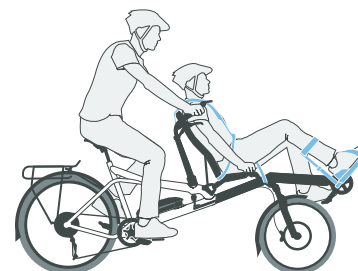

- > With its freewheel, seat expansions, special harnesses and adaptive pedals, the PINO can be a game changer for people with disabilities, in many cases making cycling possible for the first time.

GET INTO THE SEAT COMFORTABLY

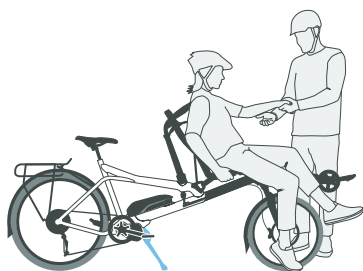

- > The PINO rests safely and securely on its double kickstand, even when loaded. This makes it easy for the rear rider to help a front passenger get into and out of the seat.

THE PINO GROWS WITH CHILDREN

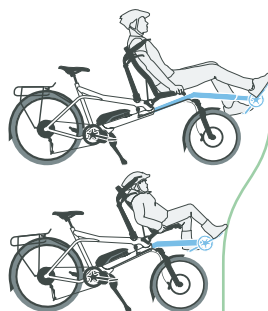

- > The PINO can be infinitely adjusted to accommodate riders as tall as 6'7" (2m) in height or – with the length-adjustable crank arms and an adapter – as small as 3'3" (1m).

ALL PACKED UP IN FIVE MINUTES

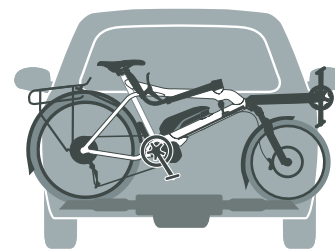

- > In no time at all, the PINO can be made as small as a 29-inch mountain bike. Then it fits onto any standard rear-mounted car rack – and therefore also on almost any car.

ACCESSORIES FOR TANDEM



01
02



02
03



01
02
03

TRANSPORT



01 Porter Bag

Even the base stats are impressive: rainproof, dustproof, and an 80-liter capacity, which, thanks to an extra zipper in the cover, can be expanded to 120 liters. The entire bag weighs a mere 3.5 pounds (1,600 g) but can hold as much as 88 pounds (40 kg). Practical: The Porter Bag can be folded up behind the seat.

02 Porter Rack

The foldable rack under the seat no longer comes with an integrated double kickstand – because otherwise, it would have to be removed every time the PINO frame is shortened for transport. Even without a kickstand, the Porter Rack is perfect for carrying heavy and bulky cargo – e.g. there is plenty of space for two beverage crates.

03 Rack Bag

We haven't made any changes to the Rack Bag, because it was already compatible with the new Porter Rack. It can even handle a certain amount of frame-shortening and only has to be removed when the PINO is reduced to its minimum length for transport.

04 Lowrider

The only difference between the new Lowrider Rack and its predecessor is the shape. Thanks to its new design, the rack doesn't have to be removed when the PINO is shortened for transport. Otherwise, nothing has changed: The Lowrider Rack is still mounted under the recumbent seat and makes it possible to carry one small and one large pannier on each side.

05 PINO Weber-Dock

Weber hitches are wonderful things – they can turn your bicycle into a towing machine for any kind of trailer – be it for children, dogs, or cargo. To make the new PINO compatible, we designed a special "Weber plate" where the hitch can be securely mounted.



01



04



02



05



03



06



07



08

TRANSPORT



06 Seatback Bag for PINO and trikes

The "glove compartment" for the captain:
This weatherproof bag with a volume of over 5 liters is attached to the back of the recumbent seat. Thanks to the Fidlock fasteners, it is easy to remove, and thanks to the carrying strap, you can simply take the whole bag with you.

SADDLE / SEAT



07 Seat Position Adapter Kid and Cargo

The adapter is needed if you want to use the Porter Rack while riding with a child in the front seat – this situation is quite common for PINO families because of all the things parents need to take with them for their kids ... With the adapter, the recumbent seat can be pushed 6 in. (15 cm) forward, which is enough for ensuring compatibility with the rack. The adapter is easy to mount. No tools required!

KICKSTANDS



08 HASE BIKES Double Kickstand

Our Double Kickstand is forged and can hold up to 220 lb (100 kg). However, it's also the rock-solid stability that sets it apart from the others. With a total width of 28 in. (70 cm) and infinitely adjustable height, the kickstand provides outstanding support for the parked PINO. It can be easily folded up and down with a rider in the front seat.

A bike can do almost anything a car can do – we at HASE BIKES know this for a fact. Sometimes, you just have to try it to believe it! In this spirit, we decided to make an irresistible offer to local car owners:





PINO

CAR

SWAP

CAR-FREE WEEKS IN WALTROP



We at HASE BIKES have nothing against cars. We even use them ourselves: for example, when the distance is too great, the cargo volume too large, or the inner couch potato too strong. When you have a PINO STEPS, these situations occur much less often than most car drivers can imagine. But talk is cheap ...

... and action is priceless – which is why we lent a PINO STEPS to five families from Waltrop and the surrounding region. No strings attached. Well, almost no strings: In return, they had to give us their car keys for safe keeping. Who took us up on the offer? Stefan Manier, cook. Dieter Link-Stern, environmental engineer. Ute Böhm, pharmacist. Kirsten Bode, physician. Jan Dickhöfer, organic farmer.

The swap took place at the end of April on the grounds of our headquarters – everything “nice” and corona compliant, with separate appointments and masks. There were on-site test rides and a few tutorials on the PINO’s handling and accessories. After the three weeks had passed, we were very curious to hear what the participants had experienced. >



RISKS AND SIDE EFFECTS ...



Risks? Addiction perhaps. Side effects? If used regularly, less stress, less back pain, and better sleep. Oh, and an increased appreciation for the simple things in life – like dry underwear. That was the conclusion reached by pharmacist Ute Böhm, who commuted to work on her PINO and seemed to always be followed by a rain cloud between Olfen and Waltrop. Nevertheless, by day three, she had started to really enjoy her commutes. And then there was also the cake that she received from a colleague who had bet her that she would never be able to survive three weeks without a car.

Ute Böhm used her PINO as not only a cargo bike, but also a tandem, for taking her daughter, Paulina, to school. Paulina worried at first that it would be embarrassing to arrive at school in the “Starship Enterprise,” but – surprise, surprise – her friends actually thought it was really cool! Which is why she gave the approval for more mother-daughter rides, with the fresh breeze in their faces and enjoyable conversations.

At the end of the three weeks, Ute Böhm won the bet and enjoyed her reward: homemade “bee-sting cake”! And we received a beautiful hand-written thank you card. We thank you, too, Ute!

... ASK YOUR DOCTOR OR PHARMACIST



Kirsten Bode is a doctor. But when she talks about risks and side effects, she's mainly thinking of the climate. And knows that reducing car use is good for not only our children's future, but also our own present. In terms of mental and physical well-being, cycling means: no traffic stress and more exercise for the heart, circulatory system, and muscles. She used her PINO on a daily basis for riding to her medical practice, doing her shopping, and even making house calls. After the three weeks, she wanted to keep the PINO – and suggested that HASE BIKES offer a PINO rental service in Waltrop. We're mulling it over. :-)

LOCAL CELEBRITY CAUGHT RED-HANDED



Fame can be a curse: When Stefan Manier “cheated” during the swap period by using a car to transport a large load of groceries for his restaurant “Gasthaus Stromberg,” he was caught in the act – by a well-informed local, who, with a smile on his face, waved a reproving finger at him and, just to make his point clear, used his hands to imitate a pedaling motion. Bad luck, you could say, but the fact is that a restaurant simply needs a lot more groceries than a family. To satisfy Stefan Manier’s needs, we would have to design a new model: the “PINO PROFESSIONAL.” We’ll have the engineering department get right on it. ;-)

Nevertheless, the cook was often able to use his PINO as a company vehicle. On Mother’s Day, it even delivered a surprise meal all the way to Recklinghausen. Meals on wheels ... of a different kind – served personally by the chef.

The chef’s conclusion? The PINO is a great family bike and the perfect vehicle for getting around town. This means that a “quick trip to the post office” is just that, and not 30 minutes of stop-and-go traffic and looking for a parking space. Stefan Manier may not have been able to manage everything without a car, but at least he didn’t need a second one! And that’s an accomplishment, in our opinion.

ENVIRONMENTAL ACTIVIST WITH SUV



You don't have to talk Dieter Link-Stern into using a bike: He uses one for 85% of the kilometers he travels. In that sense, the remaining 15% are barely worth mentioning.

He applied for the swap because the PINO was so different than all the other bikes he knows. After the three weeks, he had grown very attached to his PINO: "This sense of space!" he gushed. "And when the boost pushes from behind ...". For the environmental engineer who worked for an automobile giant, the PINO is an SUV that lets you experience the environment with all your senses, instead of polluting it. And every day, it filled him with exhilaration and delight! [➔](#)

BIKE FOR FRIDA



Frida doesn't even own a car. It would be odd if she did – as she's only 13. This meant that she had nothing to swap for a PINO, so she had to hijack one. And because of her incredibly disarming personality, her father, Jan, was unable to stop her. At least the organic farmer was allowed to borrow the PINO now and then – for example, in order to collect the freshly laid eggs from the mobile chicken coop in the middle of his green fields. Otherwise, Frida used the PINO for herself,

sometimes with a friend. And her parents? Thought it was great to see the autonomy it gave their daughter, who – because the family's organic farm is way out in the boondocks – otherwise had to be taxied around by her parents. Thanks to the PINO, they didn't have to take Frida anywhere, and she even took over the family shopping for the whole three weeks – the only things they didn't let her transport were heavy beverage crates. Which probably would have been a piece of cake for Frida and the PINO ...



And Frida herself? She had loads of fun with “here left, now right, then straight across the field” tours with her friend or spontaneous visits to the animals on the farm, which didn’t seem at all afraid of the unusual two-wheeler. Frida was also thrilled to learn that she had earned the high score on the challenge by cycling a total of 350 miles (564 km). Well, where there’s a will, there’s Frida.

From here, the story takes a slightly criminal twist. Frida didn’t want to return her PINO after three weeks, so she tried to bribe Kirsten Hase with a vegetable bed in her parents’ Demeter garden – for life. First piracy, then bribery – what will become of her? The godmother of Waltrop?? The Greta of the green transport revolution??? We can’t wait to find out! —————✘





* Translation for adults: The adaptive trikes and tandems from HASE BIKES make it possible for kids with disabilities to experience independent mobility. They help develop motor and social skills – and most importantly, build self-esteem.



03.

ADAPTIVE TRIKES FOR KIDS

KNOW YOUR LIMITS, THEN DEFY THEM

The trikes and tandems from HASE BIKES are waiting for you. Waiting for you to slip your feet into the pedals and unleash your inner explorer. You have the right to go your own way – and if you can't walk it, then ride it! Discover the exhilaration, feel the wind on your face, rail the corners, and let the mud fly. You'll LOL so much more when you're AFK ... fun, friends, and freedom are right outside your door.*



A PRESCRIPTION FOR ACTION? TRIKE IT OUT!

— If you want to move forward, just put up your feet and lean back in your seat. Sounds like a paradox, but it's actually just TRIX. A recumbent trike with a low center of gravity, the TRIX is so stable and agile that even riders with severe disabilities won't have any problem leading the pack – and looking effortlessly cool while doing so.

Anyone between 4'1" and 6'3" (1.25 and 1.90 m) has a license to trix. Riders with a need for speed can rely on the high-quality disc brakes that come standard with the TRIX. And those who have trouble pedaling smoothly can choose to ride with a fixed gear. The TRIX may not be able to move mountains, but it can ride around them, and triking over them is pretty fun too.





Specs and Features

- _ Aluminum, quick-adjust frame, foldable
- _ 67-90½ x 34 x 31½ in. (170-230 x 86 x 80 cm),
folded 45½ x 34 x 24 in. (116 x 86 x 61 cm),
seat height 19½ in. (50 cm), bottom bracket height
17 in. (43 cm)
- _ Height of rider 4'1"-6'3" (125-190 cm)
- _ 46 lb (21 kg), max. load 309 lb (140 kg)
- _ 8-speed Nexus Premium gear hub
- _ Pedals with Toe Clips and Straps
- _ Crankset 140 mm 32 T
- _ aluminum double-walled rims,
SAPIM stainless-steel spokes
- _ Reflective spoke protectors
- _ Lighting system with rechargeable battery: B+M
Lumotec IQ Eyro headlight, Toplight Flat S Perma-
nent taillight
- _ Yellow

Detailed information on specs and features can be found at <https://konfigurator.hasebikes.com/en/>.



01
Small hands? No problem with the TRIX: Its special **children's brake levers** feature a shorter reach so that young pilots can keep control of the action just as well as the grown-ups. If needed, the TRIX can also be equipped with single-hand controls.



02
The TRIX comes with **spoke protectors** ... and they're not just for advertising. Although, admittedly, we are pretty proud of our trikes. But more than anything, the protective covers are there for safety, so that nothing can get caught in the spokes – and the spinning graphics look amazing when you start to pick up speed!

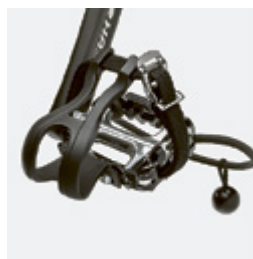

03
Recumbent trikes are particularly intuitive for kids to ride because they can see their legs while pedaling. To make sure their feet are held securely in place, the pedals are equipped with **toe clips and straps**. Pedals with calf support, along with many other adaptive accessories, are also available.



HAPPINESS WITH HANDLEBARS

The newest trike from HASE BIKES is a trike for the youngest riders. To be exact: an infinitely adjustable trike for all kids between 3'3" and 5'3" in height (1-1.6 m). The new TRETS has easy-to-use under-seat handlebars. They make young riders feel pretty cool – and honestly, they are! Those who think above-seat handlebars are even cooler can order them as an option. For more information, see page 31.

And now the wow factor: If the TRETS' poison-green finish wasn't eye-catching enough – there's also a set of funky stickers! Kids can choose between wild dinosaur or pink "Glam." Neither is meant for girls or boys only – everyone should simply choose the stickers they like most!



TRETS



Specs and Features

- _ Aluminum frame and fork
- _ Under-seat steering
- _ 60-70½ x 29 x 27-31 in. (152-179 x 73 x 68-78 cm), 65-75½ x 29 x 27-31 in. (165-192 x 73 x 68-78 cm) in trailer mode, seat height 13-17 in. (33-43 cm), bottom bracket height 12½ in. (32 cm)
- _ Height of rider 3'3"-5'3" (100-160 cm)
- _ 43 lb (19.5 kg), max. load 220 lb (100 kg), max. load in trailer mode 176 lb (80 kg)
- _ 8-speed Nexus premium gear hub
- _ Pedals with Toe Clips and Straps
- _ Crankset 115 mm 32 T
- _ aluminum double-walled rims, SAPIM stainless-steel spokes
- _ Reflective spoke protectors
- _ Lighting system with rechargeable battery: Spanninga Axendo headlight, Spanninga Elips taillight
- _ Green/black

Detailed information on specs and features can be found at <https://konfigurator.hasebikes.com/en/>.

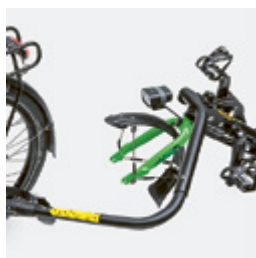

01

Remove the front wheel, attach the draw bar, and the trike is in **trailer mode**. Then it can be hitched to one of the parents' bikes for long bike tours or for taking tired toddlers home from nursery school. Oh yeah, and there's also a Guide Bar. All parents know why ...



02

Please stay seated: The **five-point harness** keeps the little ones in their seat – even when cornering at high speeds. Ideal for riders who are unable to hold themselves upright, for kids with the fidgets, and for anxious parents.



03

Thanks to its modular design, the TRETs can grow with the child and be easily adjusted to fit riders of all shapes and sizes. For the **stepless length adjustment**, all you have to do is open a lever and slide the seat into the appropriate position. Without tools and without having to shorten the chain!



WHO? WHERE? HOW?

> WHO CAN BE A HASE BIKER?

There are more possibilities than you'd expect! Thanks to the intuitive controls, exceptional safety features, and numerous technical solutions for special needs, it's even possible to ride these trikes with severe physical and/or mental impairments. But there's only one way to find out whether it works for you: [trike it out!](#)

> WHERE CAN YOU TAKE A TEST RIDE?

Worldwide, there are more than 550 HASE BIKES dealers who keep our bikes and trikes in stock for test-riding. Just give it a try – in the worst case, the rider will simply enjoy sitting in the comfy recumbent seat, but in the best case, the sitting will turn into riding, and the delight will be written all over their face. The addresses of HASE BIKES' dealers can be found on our website:

www.hasebikes.com

FUN TO THE POWER OF TWO! PINO!

A bike with a heart for families – that's the PINO, a semi-recumbent tandem, on which you'll always reach your destination together. Whether it's down the street for an ice cream cone with sprinkles or a weekend trip to the lake, the little ones always enjoy a front-row seat!

Curious? More information on the PINO is provided on pages 36 to 53 of this catalog. At hasebikes.com, you can find features like the HASE BIKES configurator or a film about Nikki Garwood, who in spite of severe disabilities has taken part in Ironman competitions with his father – and crossed the finish line on a PINO!







WELCOME TO WALTROP*

It's a great place. The historical site of the former coal mine Zeche Hibernia in Waltrop, with red-brick industrial architecture surrounded by lots of green, is not only a popular place for outings, but also a great place to work. Our manufacturing facility for specialized bikes employs more than 80 people who have turned their passion into a profession. It's a place where craftsmanship meets headwork, expert knowledge meets lateral thinking, and idealism meets reality. After more than 25 years, we're large enough to have specialists for everything – but still small enough for everyone to know each other. Thank goodness!

* Would you like to come for a visit? Make an appointment at <https://hasebikes.com/31-1-COMPANY-TOUR.html>



01



02

01

Groundbreaking ceremony for Hall 4: where all future production will take place! The first of office renovations in the historically protected colliery building, where we first set up shop in 2001, are already finished.



01 03



02

Having employees from all over the world is not only amazing, but also delicious! At the summer party, everyone brought a dish from their home country. There was hummus, pastel de nata, and of course potato salad.

03

Catch the Beast! Together with Alice and the white rabbit, HASE BIKES campaigned for more life in the city center and called upon locals to accept the "PINO Car Swap" challenge.

04

The "Chocolate Tour" is a great event for promoting emission-free transport. Kilian has twice taken part on our behalf, bringing fair-trade chocolate from Amsterdam by bike. For more info (in German): schokofahrt.de

Our Company



05

04



05

In 2019, we turned 25. Meaning that we're still young enough to march (or in our case, "pedal") for Fridays for Future. Or perhaps finally old enough to take action on behalf of future generations.

06

If our dealers can't come to us, we go to them: in 2020, owing to corona, we organized our first-ever online dealer workshop. It went well, but wasn't quite the same without the festivities ...



06







04.

SPECIAL

ACCESSORIES

THE HASE IS IN THE DETAILS

HASE BIKES makes the seemingly impossible possible. For us, it's the most normal thing in the world that people with physical or mental disabilities can enjoy cycling. HASE BIKES was founded 25 years ago in order to make this possible. Therefore, over the years, we have developed not only our special trikes and tandems but also a lot of accessories that compensate for various physical limitations or offer special protection. Whether you plan to ride alone or with a partner or two.

SPECIAL ACCESSORIES AND OPTIONS



01 Crank with adjustable length

This crankset for the front rider has crank arms that can be quickly adjusted to the leg length of the rider. No tools required! This is useful for therapeutic purposes, but also makes it possible for the smallest co-pilots to help with the pedaling. If you're riding solo with the PINO in cargo-bike mode, the crankset can be positioned under the Porter Bag with the crank arms pushed all the way in!

02 Pedals with Toe Clips and Straps

The toe clips hold the front of the foot securely, keeping the foot in the correct position. The elastic cord around the heel prevents the foot from slipping. Also available in a children's version.

03 Special Pedals

We designed our Special Pedals in cooperation with Ergodynamik Busch. They are perfectly adjustable to all needs and preferences: For starters, they fit an impressive range of shoe sizes, from US kids' 1 to US men's 16 – which makes our pedals unique. And the angle to the direction of travel can also be adjusted over a very wide range. Once the pedal has been adjusted, it's easy to fasten and release the strap with a single hand. The foot is held comfortably and securely in the proper position. The pedal is also suitable for riders who pedal with their heels.

04 Calf Support

The Calf Support was also designed for use with the Special Pedals. What makes it so special: In spite of the firm leg support it provides, the ankle joint – thanks to an adjustable elastomer spring – remains flexible, allowing for a circular pedaling motion. This is important because, when a joint is immobilized, the muscles atrophy.





04



03



03



04
∨

03

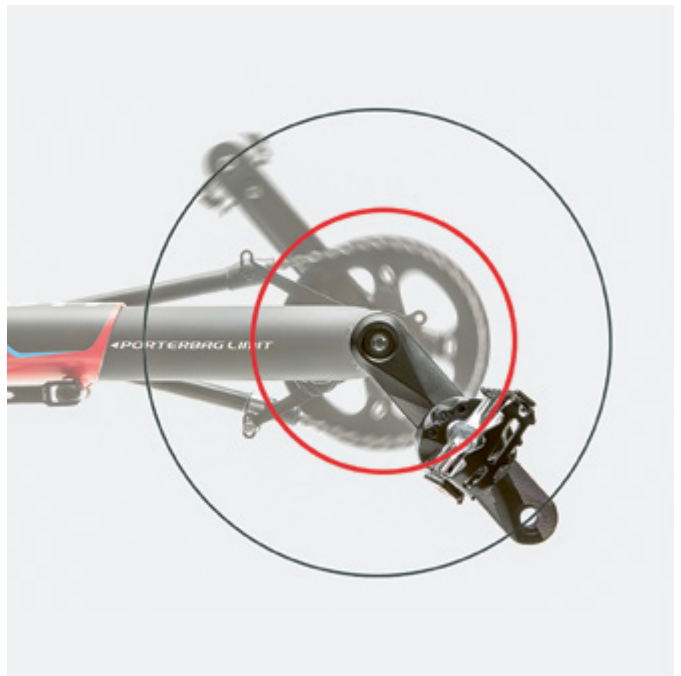
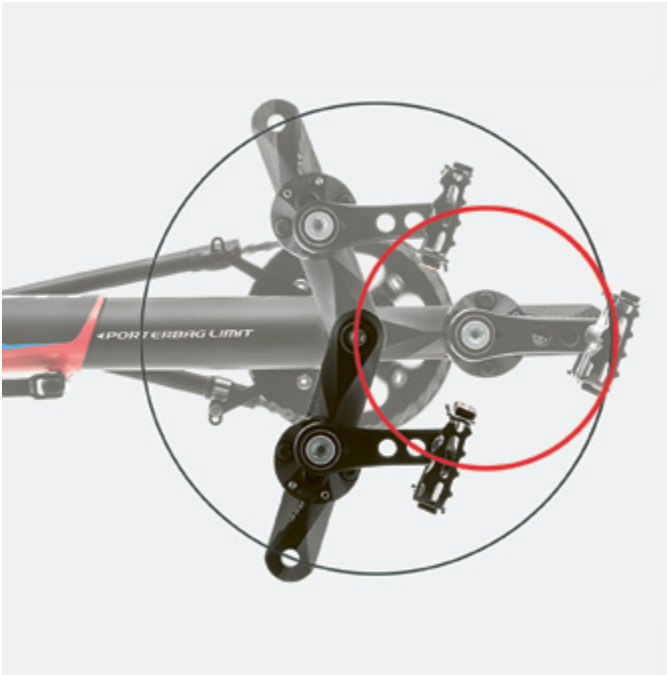

Special Accessories and Options

05 Crank Shortener with angle compensation

The Crank Shortener makes it possible to freely adjust the length of the crank arms, e.g. for riders with legs of different lengths. The forged part not only looks good but also is more robust and can even be properly aligned on offset crank arms.

06 Pendulum Pedal with angle compensation

The Pendulum Pedal can help riders with severely limited knee and hip joint movement to slowly regain their mobility. The design of the Pendulum Pedal has been slightly updated, and a new hole has been added. This hole can be used for reaching the bolts of the Crank Shortener, which saves time and hassle when removing the accessory or making adjustments.

07 Armrest

The comfortable armrest allows for a relaxed posture if a rider cannot hold the weight of their arm without support.

08 One-Sided Leg Support

Our solution for people with one-sided paralysis or disability. The healthy leg pedals, while the other is strapped comfortably and securely in place.

09 Trailer Kit (optional)

With the Trailer Kit, even normal upright bikes can be used for towing a TRIKE. The integrated overrun brake system works automatically: When the towing bike brakes, the TRIKE brakes with it.

10 Holder for Walking Stick

Just place the walking stick or cane in the holder, secure it with the clamp, and you're ready to go. Multifunctional.

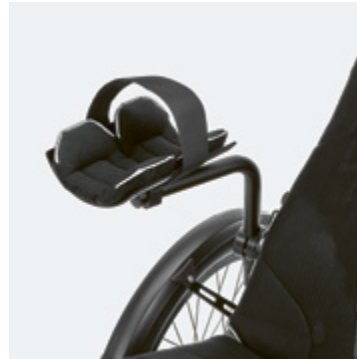

07



08



09



10



11



12

11 Extra-Long Handlebar Grips

The Extra-Long Handlebar Grips for the KETTWIESEL and LEPUS are 16 inches (40 cm) longer than the standard grips. This is ideal for people with very short arms.

12 Hand-Crank Assembly PINO (optional)

The crank for anyone who would like to help with the pedaling in the front seat of the PINO in spite of limited leg function. The Hand-Crank Assembly is height-adjustable and can be folded forward when the rider is getting into and out of the seat.



13



14



15



16



17



18



19

13 Telescopic Safety Flag with Mount

The telescopic pole with the yellow flag has a high-quality design. It can be mounted securely to the trike using a special HASE BIKES bracket. This safety accessory is also compatible with the Foldable Fairing and the Rain Cover for the seat.

14 Safety Cover for Wheels

Prevents riders from coming in contact with the wheels or brake discs – for extra safety.

15 Harness System

The Harness System with magnetic buckle and child-proof buckle guard is flexible and easy to open and close. It can be used as a combined lap and shoulder restraint or, with an additional strap between the legs, as a 5-point harness. (optional pads)

16 Gear hub with freewheel switch-off

Small Shifting Ring, big effect: Thanks to the HASE BIKES accessory for the Nexus hub, it is possible to effortlessly switch from a fixed gear to an 8-speed drive with a freewheel mechanism, and back again.

17 Single-Hand Controls

A single grip with all control elements! Using a special adapter, two brake levers can be mounted on one side. This allows the rider to shift gears and control both brake levers using a single hand.

18 Steerable Guide Bar

The steerable Guide Bar with brake lever gives the support person full control of the trike, but they can turn this control back over to the rider at any time.

19 Hydraulic Coaster Brake (optional)

If the legs are more mobile than the hands, the coaster brake ensures full braking power – with high tech: Pedaling backwards transfers the leg power to a hydraulic disc brake.

20 Headrest

For big and small, for trikes and tandems:
The Headrest can be attached to the back of the recumbent seat and offers extra comfort for the rider. If side support is also needed, the wings on the right and left can be folded forward to hold and protect the rider's head. In the third position, it becomes a neck support – e.g. for helmet wearers.

21 XXL Seat (optional)

The KETTWIESEL seat is also available in XXL. It offers extensive adjustability and has an extra 2¾ inches (7 cm) of space to comfortably accommodate riders of all shapes and sizes.

22 Seat Extension

The extension option for our standard seat increases the seat size so that your weight is distributed more evenly over a larger surface area. For people with disabilities or large riders. Not compatible with TRIGO or TRET.S.

23 Ergonomic Push Bar

If a triker needs a little help getting their wheels rolling, e.g. because they are riding without a freewheel mechanism: The Ergonomic Push Bar not only helps the triker, but also prevents strain on the hands and wrists of the person doing the pushing. Not compatible with TRIGO or TRET.S.

24 Turn Signal System

More attractive, durable, and sophisticated: The redesigned Turn Signal System with hazard-light function. It also provides the rider with a visual and acoustic signal when it's blinking. The battery-powered system is attached to the seatback, and the controls to the handlebar grips – either one button on each side or both buttons on a single grip.



20



21



22



23

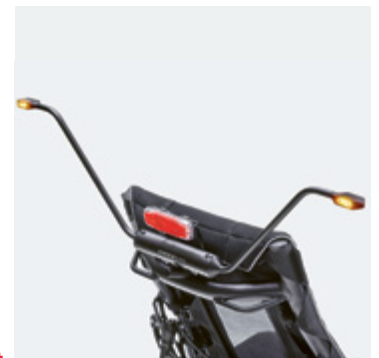

24



*OVER 550 DEALERS
WORLDWIDE*

The next HASE BIKES dealer may not be right around the corner, but there's definitely one on your continent. All addresses can be found on our website!

NO CONSULTATION, NO BIKE? EXACTLY.

HASE BIKES does not have an online shop because it is not possible to test-ride a vehicle digitally – and test rides are essential for learning about all of the available options. In addition, the high quality of our bikes and trikes can only be fully experienced when they are adjusted to the rider.

This is exactly what our trusted dealers offer. They are not only incredibly knowledgeable about bikes, but also have extensive experience in the area of adaptive cycling. With their knowledge of ergonomics and physiology, they can find the right model for every rider and adjust it perfectly to their body size and needs. In addition, they are reliable partners when it comes to making additional adjustments, performing maintenance work, making repairs, etc.

What we value most of all in our dealers is how much they love helping people experience cycling. With a whole lot of know-how, lateral thinking, and occasionally unorthodox approaches, they are often able to make the apparently impossible possible – which always makes us happy and even a little proud. And of course they know exactly which trikes can be listed as therapeutic appliances and covered by insurance providers in their country!



PREMIUM DEALERS

HASE BIKES' Premium Dealers stock the models TRIGO/TRIGO UP, PINO ALLROUND and Steps, KETTWIESEL EVO STEPS, LEPUS STEPS, and all of our racks and bags.



TOP DEALERS

At HASE BIKES' Top Dealers, you can always find the models TRIGO/TRIGO UP and PINO STEPS, including the corresponding bags and PORTER RACK, along with either the KETTWIESEL EVO STEPS or the LEPUS STEPS.



PINO DEALERS

Our HASE BIKES PINO Dealers stock the models PINO ALLROUND and PINO STEPS, along with the corresponding bags and the PORTER RACK.



ADAPTIVE DEALERS

HASE BIKES Adaptive Dealers specialize in our TRIX and TRET'S Reh, as well as our adaptive accessories. Through our Adaptive Dealers, it is possible to invoice health insurance companies (depending on the country).

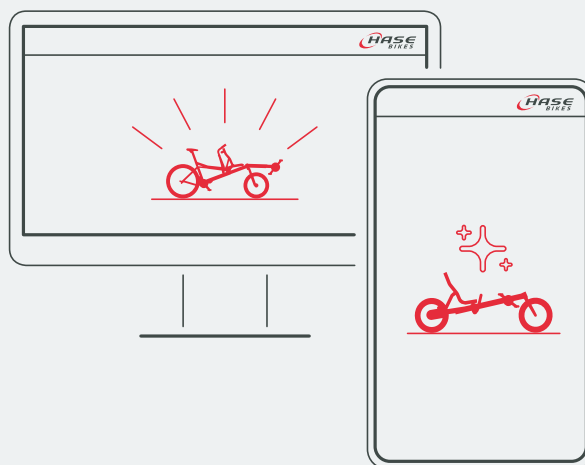

THE END ... AND THE BEGINNING

Welcome to the last page of our catalog. We squeezed in as much information as we could. But of course, there's so much more we'd love to tell and show you. That's exactly what we do on our website.

Along with more information on our trikes, bikes, and accessories – and fascinating stories about HASE BIKES and our customers – you can find many great things that aren't possible in printed form: e.g. a **configurator for creating your dream bike or trike**, an **interactive dealer map**, **downloadable brochures**, and **lots of videos**. There are also links to our channels on instagram, youtube, twitter and facebook.

WWW.HASEBIKES.COM

IMPRINT

HASE BIKES

Dipl.-Ing. Marec Hase

Hiberniastraße 2
D-45731 Waltrop

Tel.: +49 23 09 – 93 77 0

Fax: +49 23 09 – 93 77 201

info@hasebikes.com

Shipping address

Landabsatz 25
D-45731 Waltrop

Responsible for content

Kirsten Hase

Concept and text

Anne K. Hüsken

Concept and design

Christoph Stahl

Photos

Holger Wens

Translation

Leslie Ocker

Printing

Druckerei Kettler, Bönen

Copyright

© 2021 HASE BIKES. All rights reserved. All texts, images, graphics, and other data are subject to copyright law and other laws protecting intellectual property rights. They may not be copied or used in modified form.



WWW.HASEBIKES.COM